

# FLEX OUTDOOR

## Specification Grade Exterior Flexible LED Tape



### DESCRIPTION

FLEX OUTDOOR is an exterior rated high CRI flexible linear LED strip designed for high-end retail establishments, luxury hotels, exclusive hospitality venues, affluent residences, and similar settings where quality illumination is desired. The flexible LED tape may be used as a standalone lighting instrument or installed into optional anodized aluminum profiles with a choice of lensing options. FLEX OUTDOOR is equally applicable for merchandising or adding accents and visual effects to architectural elements for ambience. The LEDs are tightly spaced at a pitch of 0.28" on a double-layer substrate for improved homogenous light output.



### FEATURES

- 2700K, 3000K or 4000K at CRI > 90
- 3000K or 4000K at CRI > 95
- Efficacies from 84 to 111 lumens per watt
- 43 LEDs per foot for homogenous light output
- Double layer substrate allows long line lengths with better stability
- Flexible LED strip installs onto surface with heat-conducting adhesive
- Optional anodized aluminum profiles with a choice of mounting hardware, and lenses. Sold in 16.4' reel lengths. Contact factory for longer lengths
- Works with 24v Remote Driver (details on page 8)
- UL Listed for Dry Locations. Suitable for use in covered or protected under canopy applications.

Date: \_\_\_\_\_ Type: \_\_\_\_\_ Catalog Number: \_\_\_\_\_

Project Name: \_\_\_\_\_

### ORDERING INFORMATION

FLEX TAPE SERIES				
MODEL	CRI	COLOR TEMPERATURE	LM/FT	REEL LENGTH
LFLEX-OD <sup>1</sup>	90	2700K	SO	5M <sup>3</sup>
LED FLEX OUTDOOR	95 <sup>2</sup>	3000K 4000K	HO	16.4' / 5 meter reel

<sup>1</sup> Power supplies, optional aluminum profiles, mounting accessories, and lenses ordered separately.

<sup>2</sup> 95 CRI only available with 3000K, 4000K

<sup>3</sup> Contact factory for longer reel lengths

# FLEX OUTDOOR

## Specification Grade Exterior Flexible LED Tape



	LFLEX-OD-90-2700K-SO-5M	LFLEX-OD-90-3000K-SO-5M	LFLEX-OD-90-4000K-SO-5M	LFLEX-OD-90-2700K-HO-5M	LFLEX-OD-90-3000K-HO-5M	LFLEX-OD-90-4000K-HO-5M
--	-------------------------	-------------------------	-------------------------	-------------------------	-------------------------	-------------------------

### PHOTOMETRIC DATA

CRI	> 90	> 90	> 90	> 90	> 90	> 90
Color Temperature	2700K	3000K	4000K	2700K	3000K	4000K
Lumens / Foot	555 lm	604 lm	610 lm	814 lm	878 lm	914 lm
Lumens / 16.4' Reel	9102 lm	9905.6 lm	10004 lm	13349.6 lm	14399.2 lm	14989.6 lm
Efficacy (Lumens per watt)	90.1 lm/W	98.0 lm/W	99.0 lm/W	84.2 lm/W	90.9 lm/W	94.6 lm/W
Beam Angle	120°	120°	120°	120°	120°	120°
Center Beam Candlepower	181 cd	197 cd	199 cd	266 cd	287 cd	299 cd
Binning (McAdam Ellipse)	SDCM3	SDCM3	SDCM3	SDCM3	SDCM3	SDCM3

### ELECTRICAL DATA

LED Voltage	24V DC	24V DC	24V DC	24V DC	24V DC	24V DC
Watts/Foot	6.2	6.2	6.2	9.7	9.7	9.7
Watts/16.4' Reel	101.68 W	101.68 W	101.68	159.08	159.08 W	159.08 W
Maximum Run Length (Feet) @ 100W	16.1'	16.1'	16.1'	10.3'	10.3'	10.3'
Maximum Run Length (Inches) @ 100W	193.5"	193.5"	193.5"	123.7"	123.7"	123.7"

	LFLEX-OD-95-3000K-SO-5M	LFLEX-OD-95-3000K-HO-5M	LFLEX-OD-95-4000K-SO-5M	LFLEX-OD-95-4000K-HO-5M
--	-------------------------	-------------------------	-------------------------	-------------------------

### PHOTOMETRIC DATA

CRI	> 95	> 95	> 95	> 95
Color Temperature	3000K	3000K	4000K	4000K
Lumens / Foot	530 lm	790 lm	610 lm	915 lm
Lumens / 16.4' Reel	8,692 lm	12,956 lm	10,004 lm	15,006 lm
Efficacy (Lumens per watt)	96 lm/W	94 lm/W	111 lm/W	109 lm/W
Beam Angle	120°	120°	120°	120°
Center Beam Candlepower	173 cd	259 cd	199 cd	299 cd
Binning (McAdam Ellipse)	SDCM3	SDCM3	SDCM3	SDCM3

### ELECTRICAL DATA

LED Voltage	24V DC	24V DC	24V DC	24V DC
Watts/Foot	5.5	8.4	5.5	8.4
Watts/16.4' Reel	90.2 W	137.8 W	90.2 W	137.8 W
Maximum Run Length (Feet) @ 100W	18'	11.9'	18'	11.9'
Maximum Run Length (Inches) @ 100W	216.5"	142"	216.5"	142"

# FLEX OUTDOOR

## Specification Grade Exterior Flexible LED Tape



### MECHANICAL DATA

Length of Reel	16.4'
Width	0.31"
Height	0.06"
Color	White
LED Pitch	0.28"
LEDs per foot	43
Segment Cut Length	1.97"
Ingress Protection	IPX6

### TEMPERATURE DATA

Rated Life (L80/B10 at 25°C)	60,000 hours
Ambient Operating Temperature	-20° to 45°C (-4°F to 113°F)
Ambient/Storage Temperature	-5°C to 55°C (23°F to 131°F)
Operating Temperature at Tc	-5°C to 60°C (23°F to 140°F)

### OTHER

Warranty	5 years
Certifications	UL Listed for Dry Locations. Suitable for use in covered or protected under canopy applications.

### DIMENSIONS (Reel Length = 16.4')

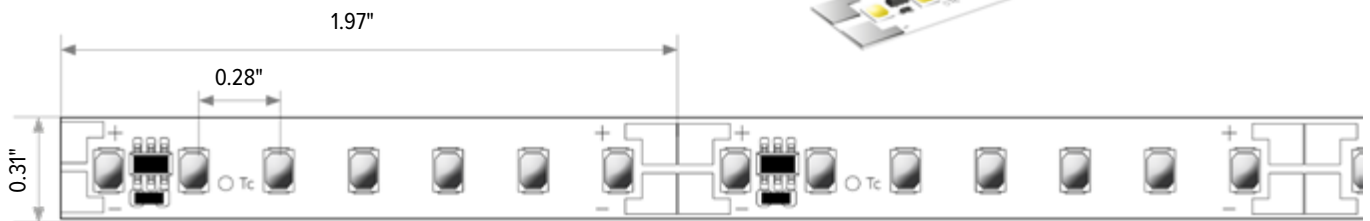

Height = 0.06"

# FLEX OUTDOOR

Specification Grade Exterior Flexible LED Tape



**PROFILES** (Sold Separately) All dimensions are shown in inches, unless noted otherwise.

WXT01				
Recessed Profile	Dimensions (L x W x H)	Finish	Maximum Watts / Ft	Weight
WXT01-6.6	6.56' x 1.18" x 0.77"	Clear Anodized	8.8 W	0.74 lbs
WXT01-9.8	9.84' x 1.18" x 0.77"	Clear Anodized	8.8 W	1.1 lbs
WXT01-XX*	XX* x 1.18" x 0.77"	Clear Anodized	8.8 W	0.11 lbs/ft

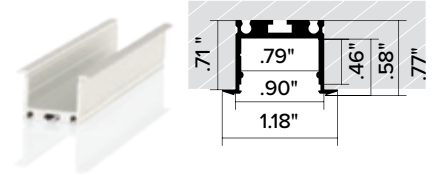

WXT02				
Surface Mount Profile	Dimensions (L x W x H)	Finish	Watts / Ft	Weight
WXT02-6.6	6.56' x 0.90" x 0.51"	Clear Anodized	8.8 W	0.59 lbs
WXT02-9.8	9.84' x 0.90" x 0.51"	Clear Anodized	8.8 W	0.88 lbs
WXT02-XX*	XX* x 0.90" x 0.51"	Clear Anodized	8.8 W	0.09 lbs/ft

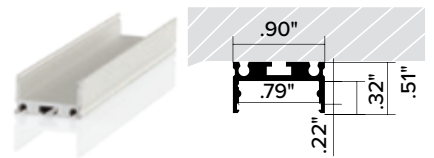

WXT03				
Surface Mount Profile	Dimensions (L x W x H)	Finish	Watts / Ft	Weight
WXT03-6.6	6.56' x 0.90" x 0.90"	Clear Anodized	8.8 W	1.54 lbs
WXT03-9.8	9.84' x 0.90" x 0.90"	Clear Anodized	8.8 W	2.30 lbs
WXT03-XX*	XX* x 0.90" x 0.90"	Clear Anodized	8.8 W	0.23 lbs/ft

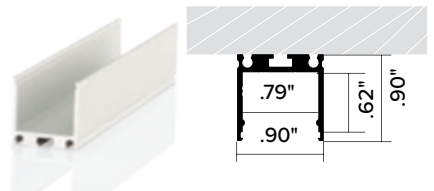

WHT01				
Recessed Profile	Dimensions (L x W x H)	Finish	Maximum Watts / Ft	Weight
WHT01-6.6	6.56' x 1.54" x .96"	Clear Anodized	10.7 W	2.69 lbs
WHT01-9.8	9.84' x 1.54" x .96"	Clear Anodized	10.7 W	4.04 lbs
WHT01-XX*	XX* x 1.54" x .96"	Clear Anodized	10.7 W	0.41 lbs/ft

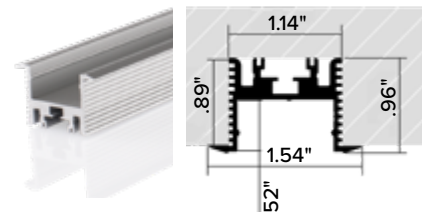

WHT02				
Surface Mount Profile	Dimensions (L x W x H)	Finish	Watts / Ft	Weight
WHT02-6.6	6.56' x 1.14" x .94"	Clear Anodized	10.7 W	2.55 lbs
WHT02-9.8	9.84' x 1.14" x .94"	Clear Anodized	10.7 W	3.82 lbs
WHT02-XX*	XX* x 1.14" x .94"	Clear Anodized	10.7 W	0.39 lbs/ft

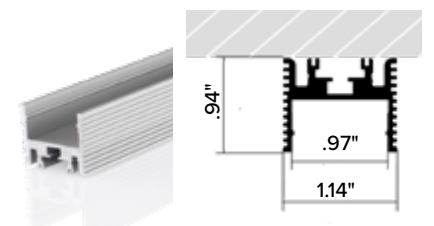

\* Specify XX in feet

# FLEX OUTDOOR

Specification Grade Exterior Flexible LED Tape



**LENS OPTIONS** (Sold Separately) Refer to chart on page 5 for End Cap & Mounting Options

FOR WXT01, WXT02, AND WXT03 PROFILES	<p><b>WSX03-xx</b> - U-Lens</p> 		<p><u>Dimensions</u></p> <p>.90" x .53"</p>	
	<p><b>WSX07</b> - Rollable Satin-Finished Lens</p> 		<p><u>Dimensions</u></p> <p>.90" x .18"</p>	
	<p><b>WSX08</b> - Rollable Transparent Lens</p> 		<p><u>Dimensions</u></p> <p>.90" x .18"</p>	
	<p><b>WSX09</b> - Satin-Finished Lens</p> 		<p><u>Dimensions</u></p> <p>.90" x .29"</p>	
	<p><b>WSX10</b> - Transparent Lens</p> 		<p><u>Dimensions</u></p> <p>.90" x .29"</p>	
	<p><b>WSX30</b> - Linear Lens</p> 		<p><u>Dimensions</u></p> <p>.93" x .36"</p>	
	FOR WHT01 AND WHT02 PROFILES	<p><b>WHX09</b> - Transparent Lens</p> 		<p><u>Dimensions</u></p> <p>1.14" x .29"</p>
<p><b>WHX10</b> - Satin-Finished Lens</p> 			<p><u>Dimensions</u></p> <p>1.14" x .29"</p>	

### AVAILABLE OPTIONS BY PROFILE SELECTION (SOLD SEPARATELY) Refer to pages 4-6 for details

WXT01 Profile Options	WXT02 Profile Options	WXT03 Profile Options	WHT01 Profile Options	WHT02 Profile Options
<b>End Caps</b>	<b>End Caps</b>	<b>End Caps</b>	<b>End Caps</b>	<b>End Caps</b>
WXT00U-E	WXT00U	WXT003U	WHT001	WHT002
WXT001	WXT002	WXT030		
<b>Mounting</b>	<b>Mounting</b>	<b>Mounting</b>	<b>Mounting</b>	<b>Mounting</b>
WXTC2 - Steel Mount	WXTC4 - Adjustable	WXTC4 - Adjustable	WXTC4 - Adjustable	WXTC4 - Adjustable
WXTC5 - 0.96" Clip	WXTC5 - 0.96" Clip	WXTC5 - 0.96" Clip	WYTV1 - Line Connector	WYTV1 - Line Connector
WXTM1 - Magnet	WXTM1 - Magnet	WXTM1 - Magnet	WYTC5 - 0.76" Clip	WYTC5 - 0.76" Clip
	WYTC8 - Swivel Mount	WYTC8 - Swivel Mount	WYTC8 - Swivel Mount	WYTC8 - Swivel Mount
		WXTA2 - Cable Suspension	WXTA2 - Cable Suspension	WXTA2 - Cable Suspension
<b>Lens</b>	<b>Lens</b>	<b>Lens</b>	<b>Lens</b>	<b>Lens</b>
WSX03-xx*	WSX03-xx*	WSX03-xx*	WHX09-xx*	WHX09-xx*
WSX07-xx*	WSX07-xx*	WSX07-xx*	WHX10-xx*	WHX10-xx*
WSX08-xx*	WSX08-xx*	WSX08-xx*		
WSX09-xx*	WSX09-xx*	WSX09-xx*		
WSX10-xx*	WSX10-xx*	WSX10-xx*		
WSX30-xx*	WSX30-xx*	WSX30-xx*		

\* Specify XX in feet

### END CAP OPTIONS (Sold Separately) Refer above for more details.

#### WXT00U-E



Dimensions

1.18" x 1.18" x .31"

Corresponding Profile

WXT01

#### WXT003U

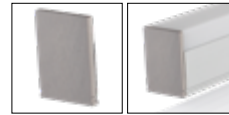

Dimensions

.90" x 1.32" x .28"

Corresponding Profile

WXT03

#### WXT001



Dimensions

1.18" x .83" x .24"

Corresponding Profile

WXT01

#### WXT030



Dimensions

.98" x .90" x .08"

Corresponding Profile

WXT03

#### WXT00U



Dimensions

.90" x .93" x .28"

Corresponding Profile

WXT02

#### WHT001

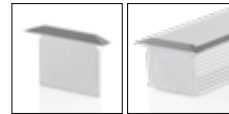

Dimensions

1.14" x .98" x .41"

Corresponding Profile

WHT01

#### WXT002



Dimensions

.90" x .55" x .08"

Corresponding Profile

WXT02

#### WHT002

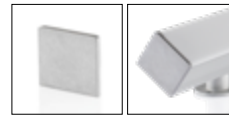

Dimensions

1.14" x .98" x .37"

Corresponding Profile

WHT02

# FLEX OUTDOOR

Specification Grade Exterior Flexible LED Tape



## MOUNTING OPTIONS (Sold Separately) Refer to pg. 5 for more details.

**WXTC2 - Steel Mount**



Dimensions

.85" x .59" x 1.57"

Corresponding Profile

WXT01



**WXTC5 - .96" Clip**

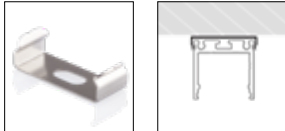

Dimensions

.96" x .29" x .39"

Corresponding Profile

WXT01, WXT02, WXT03



**WXTM1 - Magnet**

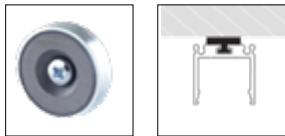

Dimensions

.79" x .24" x .79"

Corresponding Profile

WXT01, WXT02, WXT03

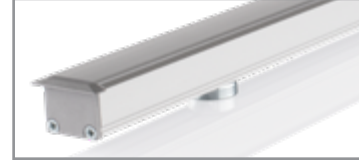

**WXTC4 - Adjustable Mount**



Dimensions

.39" x .55" x .57"

Corresponding Profile

WXT02, WXT03, WHT01, WHT02



**WYTC8 - Swivel Mount**



Dimensions

1.18" x 1.10" x 1.18"

Corresponding Profile

WXT02, WXT03, WHT01, WHT02



**WXTA2 - Cable Sus-**

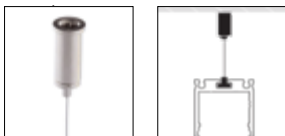

Dimensions

.08"

Corresponding Profile

WXT03, WHT01, WHT02

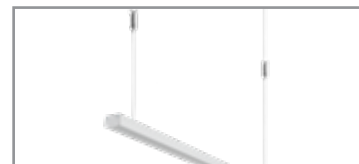

**WYTV1 - Line Conne-**

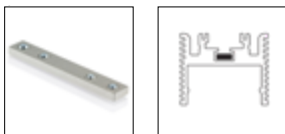

Dimensions

.24" x .14" x .197"

Corresponding Profile

WHT01, WHT02



**WYTC5 - .76" Clip**

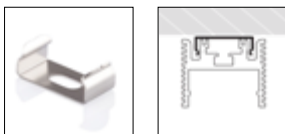

Dimensions

.76" x .30" x .39"

Corresponding Profile

WHT01, WHT02

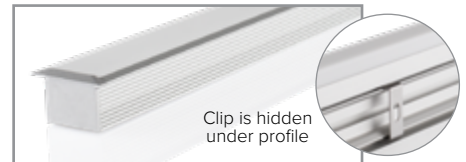

# FLEX OUTDOOR

Specification Grade Exterior Flexible LED Tape



## DRIVER VZM060W-24 / VZM100W - 24 DIMENSIONS

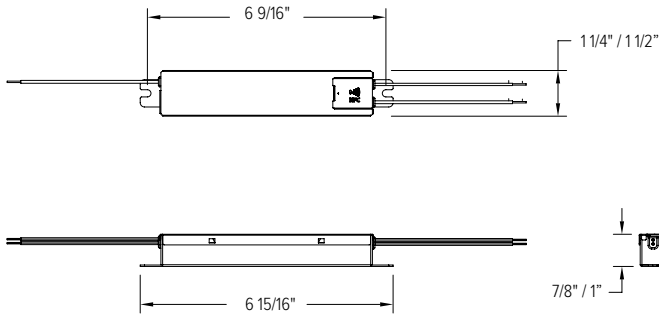

### VZM060W-24 / VZM100W-24

Driver	Nominal Input Voltage (VAC)	# of Channels	Pout Max (W)	Vout Max (Vdc)	Iout Min (A)	Iout Max (A)	Open Loop Voltage (No Load Vout Max) (Vdc)	Comments
VZM060W-24	120 & 277	1	60	24	0.25	2.50	25.68	Aluminum case with flying leads
VZM100W-24	120 & 277	1	90	24	0.38	3.75	25.68	Aluminum case with flying leads

## XLD DRIVER DIMENSIONS

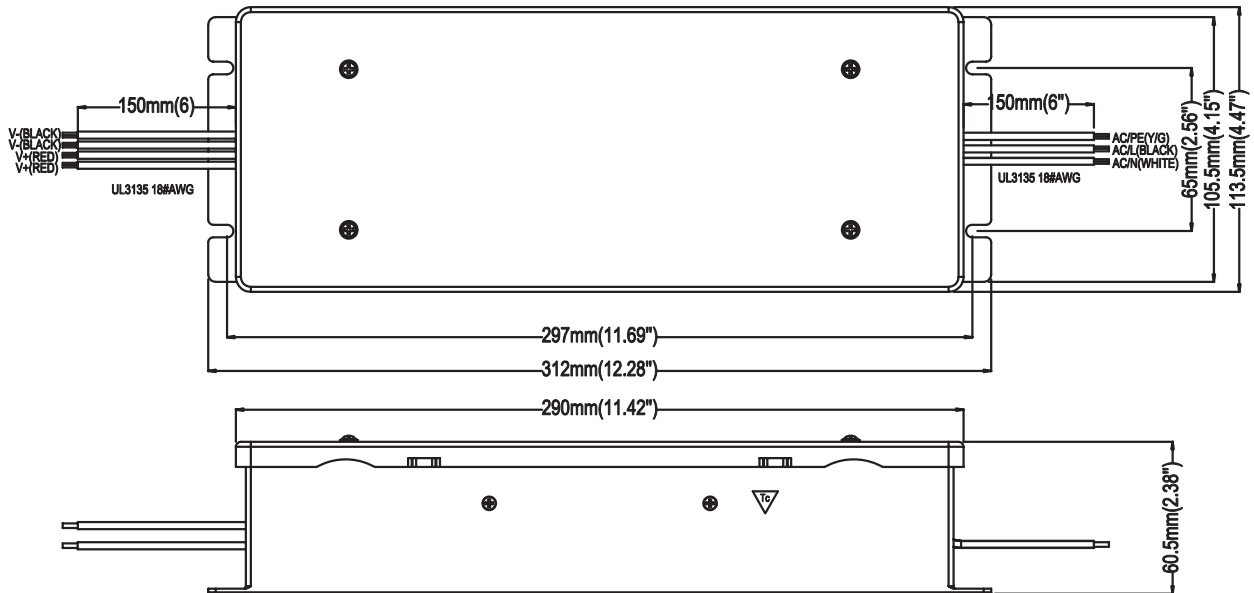

### XLD Driver

Driver	Nominal Input Voltage (VAC)	# of Channels	Pout Max (W)	Vout Max (Vdc)	Iout Min (A)	Iout Max (A)	Open Loop Voltage (No Load Vout Max) (Vdc)	Comments
XLD200-2-24V-FC	90 - 305	2	100	24	0.42	8.75	25.2	Aluminum case with flying leads

# FLEX OUTDOOR

Specification Grade Exterior Flexible LED Tape



## PHOTOMETRICS

### PHOTOMETRIC FILENAME

**LFLEX-OD-90-2700K-SO.IES**

Color Temperature (CCT) = 2700K

Color Rendering (CRI) = 90

Delivered Lumens = 555 lm/ft

Maximum Candela = 181 cd

Beam Angle = 120°

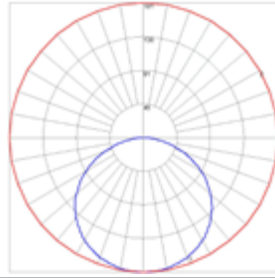

### PHOTOMETRIC FILENAME

**LFLEX-OD-90-2700K-HO.IES**

Color Temperature (CCT) = 2700K

Color Rendering (CRI) = 90

Delivered Lumens = 814 lm/ft

Maximum Candela = 266 cd

Beam Angle = 120°

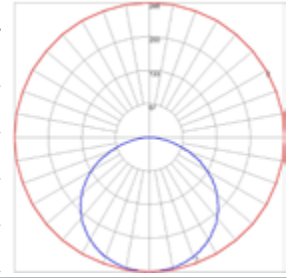

### PHOTOMETRIC FILENAME

**LFLEX-OD-90-3000K-SO.IES**

Color Temperature (CCT) = 3000K

Color Rendering (CRI) = 90

Delivered Lumens = 604 lm/ft

Maximum Candela = 197 cd

Beam Angle = 120°

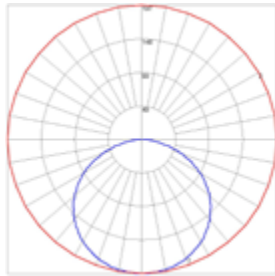

### PHOTOMETRIC FILENAME

**LFLEX-OD-90-3000K-HO.IES**

Color Temperature (CCT) = 3000K

Color Rendering (CRI) = 90

Delivered Lumens = 878 lm/ft

Maximum Candela = 287 cd

Beam Angle = 120°

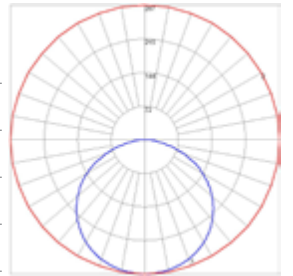

### PHOTOMETRIC FILENAME

**LFLEX-OD-90-4000K-SO.IES**

Color Temperature (CCT) = 4000K

Color Rendering (CRI) = 90

Delivered Lumens = 610 lm/ft

Maximum Candela = 199 cd

Beam Angle = 120°

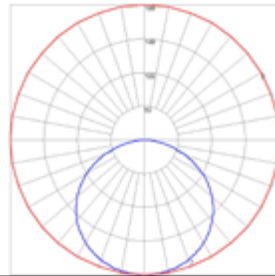

### PHOTOMETRIC FILENAME

**LFLEX-OD-90-4000K-HO.IES**

Color Temperature (CCT) = 4000K

Color Rendering (CRI) = 90

Delivered Lumens = 914 lm/ft

Maximum Candela = 299 cd

Beam Angle = 120°

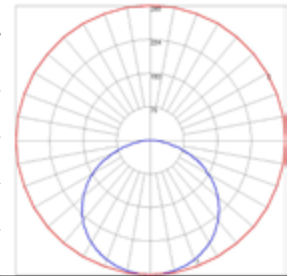

### PHOTOMETRIC FILENAME

**LFLEX-OD-95-3000K-SO.IES**

Color Temperature (CCT) = 3000K

Color Rendering (CRI) = 95

Delivered Lumens = 530 lm/ft

Maximum Candela = 173 cd

Beam Angle = 120°

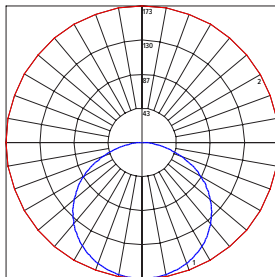

### PHOTOMETRIC FILENAME

**LFLEX-OD-95-4000K-SO.IES**

Color Temperature (CCT) = 4000K

Color Rendering (CRI) = 95

Delivered Lumens = 610 lm/ft

Maximum Candela = 199 cd

Beam Angle = 120°

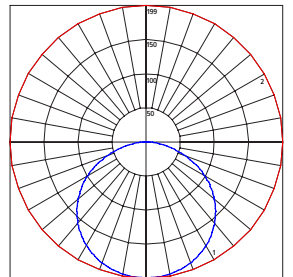

### PHOTOMETRIC FILENAME

**LFLEX-OD-95-3000K-HO.IES**

Color Temperature (CCT) = 3000K

Color Rendering (CRI) = 95

Delivered Lumens = 792 lm/ft

Maximum Candela = 259 cd

Beam Angle = 120°

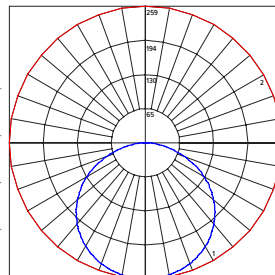

### PHOTOMETRIC FILENAME

**LFLEX-OD-95-4000K-HO.IES**

Color Temperature (CCT) = 4000K

Color Rendering (CRI) = 95

Delivered Lumens = 914 lm/ft

Maximum Candela = 299 cd

Beam Angle = 120°

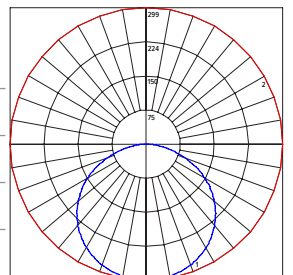

# FLEX OUTDOOR

Specification Grade Exterior Flexible LED Tape

