

PUCK XT

Recessed LED Handrail Luminaire



DESCRIPTION

Puck XT is a self-contained recessed luminaire for installation into round or square metal handrail profiles or similar metallic structures. The lighting module is available in warm or neutral color temperatures with a choice of light distributions to satisfy a variety of installation conditions.

FEATURES

- Self-contained stainless steel IP-66 rated LED module
- Remote driver allows up to 15 PUCK XT modules per circuit
- Shunt bypass allows remaining modules to operate in case of single failure
- Three light distributions to meet varying applications
- 2700K, 3000K, or 4000K color temperatures, or True Amber



Date: _____ Type: _____ Catalog Number: _____

Project Name: _____



ORDERING INFORMATION

LUMINAIRE			
MODEL	APPLICATION	CCT	OPTIC
PUCK-XT LED Handrail Module	RD Round Handrail	27K 2700K	ASB Asymmetric Beam
	SQ Square Handrail	30K 3000K	DSB Double-Sided Beam
		40K 4000K	OSB* One-Sided Beam (*for round handrail applications only)
		A True Amber (590 to 595nm - Extended Lead Time)	

REMOTE POWER SUPPLY WITH ENCLOSURE

RMTPS-UNV-20-500-DIM
Remote Power Supply With Enclosure, Universal 120/277v Input, 20 Watts, 500mA Drive Current, 0-10v Dimming; Powers 1 to 12 PUCK XT LED Modules

RMTPS-UNV-25-500-DIM
Remote Power Supply With Enclosure, Universal 120/277v Input, 25 Watts, 500mA Drive Current, 0-10v Dimming; Powers 4 to 15 PUCK XT LED Modules

ACCESSORIES

MP003 Gel-Filled Connector	MP098 17mm Drill Bit
MP011 PUCK XT Installation Tool	MP099 17mm Tap
MP016 PUCK XT Drill Guide Jig	



www.WilaNorthAmerica.com
For other Experience® Brands companies, please visit www.ExperienceBrandsUSA.com.

In a continuing effort to offer the best product possible, we reserve the right to change, without notice, specifications or materials. Technical specification sheets that appear online are the most recent ones available. *Consult the factory to verify current status of BAA/TAA/BABAA compliance.

PUCK XT

Recessed LED Handrail Luminaire



		PUCK XT
PHYSICAL	HOUSING	316 Stainless Steel
	LENS	Polycarbonate
	DRIVER LOCATION	Remote (Ordered Separately)
	DIMENSIONS	ø 0.7" x 0.6" Depth
	INSTALLATION DEPTH	0.7"
	WEIGHT	18 Ounces
	OPERATING TEMPERATURE	-4°F to 140°F (-20°C to 60°C)
	THREAD SIZE	M18 x 1 Note: For round railing, Puck XT is compatible with diameters from 1.5" to 3.9" (38mm to 100mm) with minimum wall thickness of 1/16" (1.5mm). ADA-compliant railing diameters are 1/4" to 2" OD.

ELECTRICAL	DRIVE CURRENT	500mA* *Note: For installation into non-metallic materials, consult factory.
	INPUT WATTS	1.5 Watts
	REMOTE POWER SUPPLY	20 Watt Remote Driver Powers 1 to 12 Luminaires 25 Watt Remote Driver Powers 4 to 15 Luminaires
	REMOTE DRIVER MOUNTING	Maximum Distance is 150 Feet

PHOTOMETRIC	CCT	Static White 2700K, 3000K, 4000K, or True Amber (590-595nm)				
	CRI	> 80				
	LUMEN OUTPUT		ROUND		SQUARE	
			3000K	4000K	3000K	4000K
		ASYMMETRIC	160	171	161	170
		DOUBLE-SIDED	175	185	176	186
		ONE-SIDE NADIR	170	180	<i>One-sided beam is only available on round handrail applications.</i>	
	ONE-SIDE 30°	147	153			
	EFFICACY	Up to 123 Lumens per Watt				
	LUMEN MAINTENANCE	L90/B10 ≥ 50,000 Hours at 77°F*				
	BUG RATING		ROUND		SQUARE	
			3000K	4000K	3000K	4000K
ASYMMETRIC		B0-U1-G0	B0-U1-G0	B0-U1-G0	B0-U1-G0	
DOUBLE-SIDED		B0-U1-G0	B0-U1-G0	B0-U0-G0	B0-U1-G0	
ONE-SIDE NADIR		B0-U1-G0	B0-U1-G0	<i>One-sided beam is only available on round handrail applications.</i>		
ONE-SIDE 30°	B0-U2-G1	B0-U2-G1				

CERTIFICATIONS	SAFETY	CSA Certified for Wet Locations <i>Amber Certification Pending.</i>
	INGRESS PROTECTION	IP66 / NEMA 4X
	IMPACT RATING	IK10
	WARRANTY	Five Year Limited Warranty

* LED life may vary under actual field conditions due to external factors. Lifetime estimates are generated from actual testing in a controlled environment. Values are conservatively derived from those numbers.

PUCK XT

Recessed LED Handrail Luminaire



DIMENSIONS

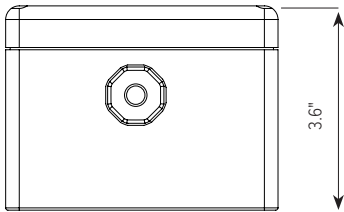
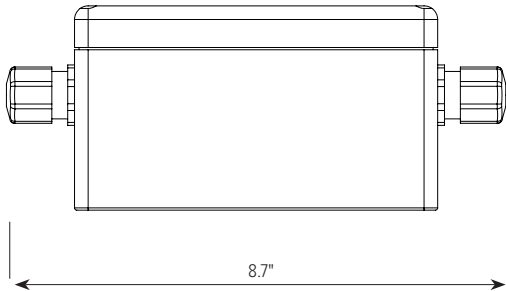
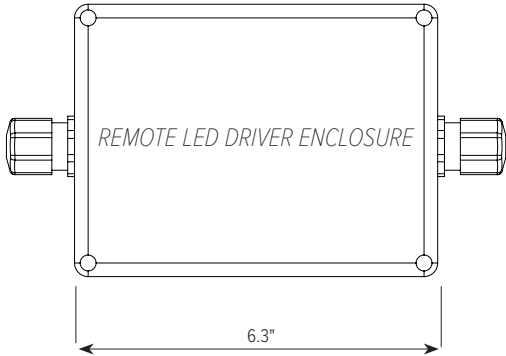
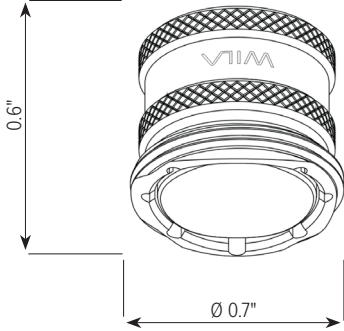

PUCK XT

Recessed LED Handrail Luminaire



PHOTOMETRICS

For Round Handrails:

- Asymmetric
- Double-Sided Beam
- One-Sided Beam

For Square Handrails:

- Asymmetric
- Double-Sided Beam

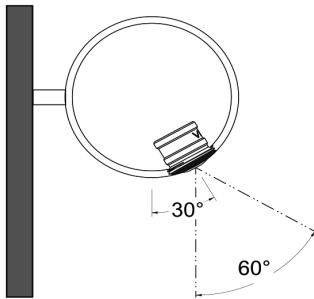
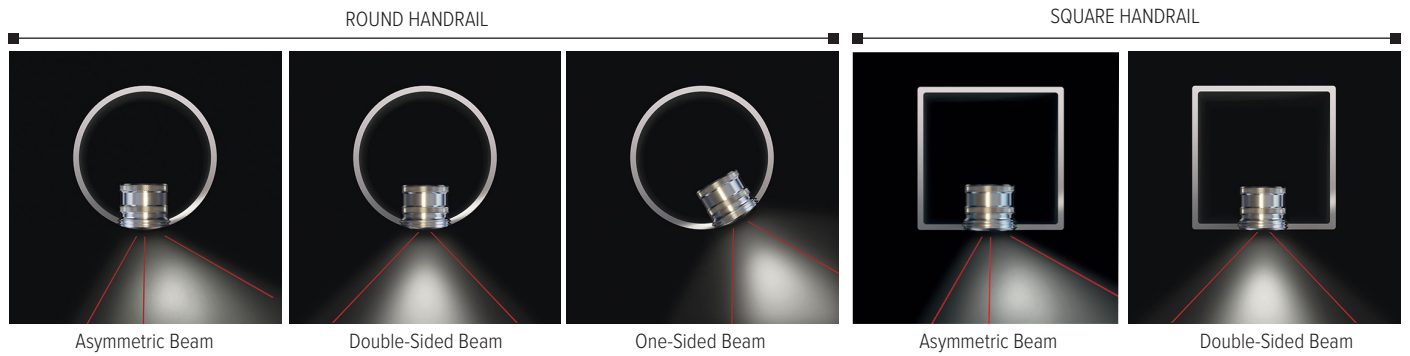

One-Sided Beam
Perimeter or wall mounted railing

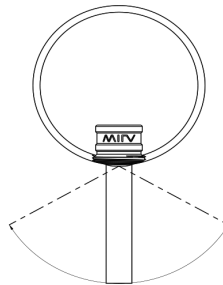

Double-Sided Beam
Interior pathway railing

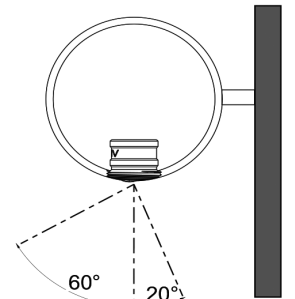

Asymmetric Beam
Perimeter or wall mounted railing

PUCK XT

Recessed LED Handrail Luminaire



ALIGNMENT ORIENTATION

Align WILA logo / indicator at right angles to handrail in the desired location of illumination. Modules have curved faces for round handrails and flat faces for square or rectangular handrails.

